

# FISCHBEIN®

## Model DRC 300™

Double Roll Closer System

## Fischbein Model DRC 300™

The Fischbein Model DRC 300™ Double Roll Closer seals multi-wall, flush-cut paper bags weighing up to 50 pounds at production rates up to 75 linear feet per minute. The Model DRC 300™ automatically trims the top of the bag, makes a single precise fold, applies hot melt adhesive, and then makes a final second fold. The patented breakaway design eliminates costly downtime caused by bag jams while allowing easy cleaning and service of the bag folder.



**EVERYTHING** IN BAGGING EQUIPMENT™



# Fischbein® Model DRC 300™

## Double Roll Closer System

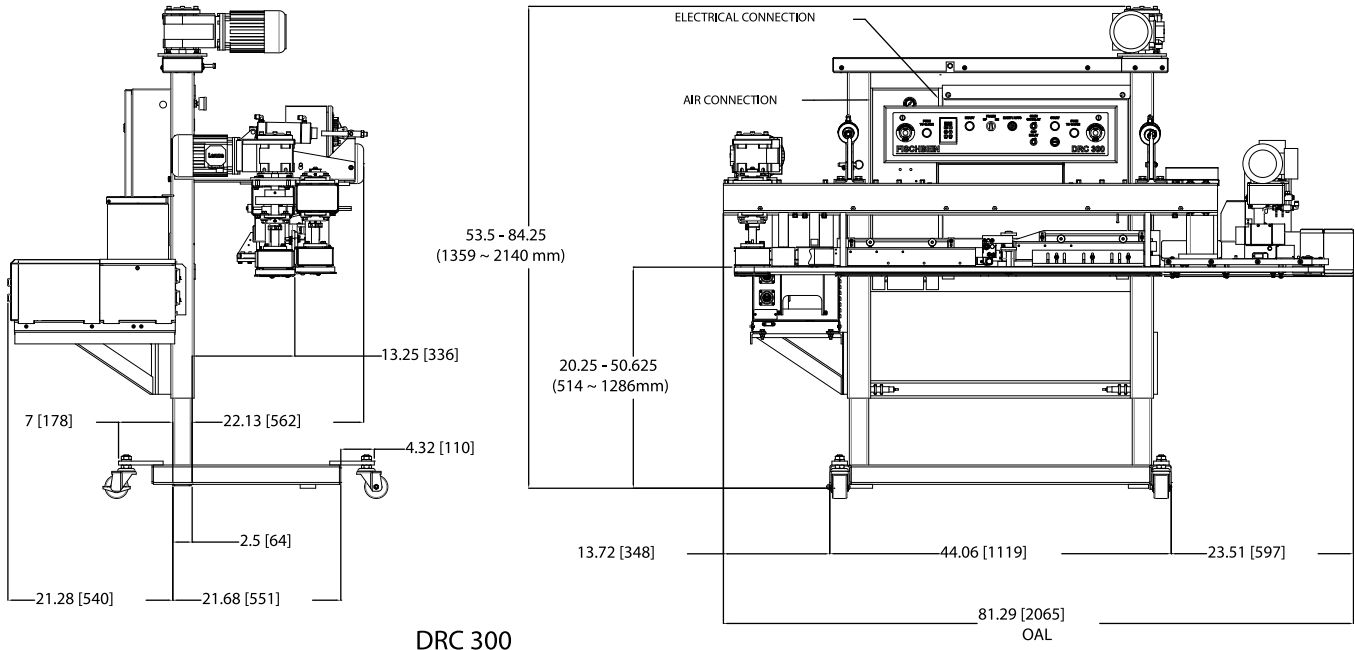

DRC 300

### FEATURES

#### BAG TYPES

Closes multi-wall paper bags.

#### SPIRAL GLIDE FOLDER TECHNOLOGY

Spiral glide folder technology creates bag closures that are consistent, reliable and attractive.

#### LOW MAINTENANCE

The patented breakaway design eliminates costly downtime caused by bag jams, while allowing easy cleaning and service of the bag folder.

#### USER FRIENDLY CONTROLS

Safe and easy to use control panel with digital temperature control and display key pad for variable speed control, and dual emergency stop buttons.

#### RIGHT TO LEFT OPERATION

#### DYNATECH HOT MELT ADHESIVE APPLICATOR

#### DUAL KNIFE BAG TOP TRIMMER

### OPTIONS

- Additional motor starter and contactor for conveyor
- CR Plus 2 part corrosion resistant powder coat finish
- Nordson brand hot melt application system
- Wide fold for larger bags - Model 300 Plus
- Left to right operation
- 460 and 575 VAC

### SPECIFICATIONS

- Dimensions: W 82 in (208 cm), D 46 in (117 cm), H 54-85 in (137-216 cm)
- Speed: Up to 75 linear feet per minute
- Electric (NEMA 12): 230V-3PH-50/60Hz, 24 VAC
- Air: 8 cfm @ 80-100 PSI

### BAGS

- Bag Types: Open mouth flat or gusseted multi-wall paper bags
- Bag Face Width: Minimum 5 in (12.7 cm)
- Free Bag Top: Minimum 6 in (15.2 cm) - standard fold  
Minimum 7.5 in (19 cm) - wide fold

### APPLICATIONS

- Fertilizers
- Pet Food
- Powdered Dairy Products
- Minerals
- Feed Additives
- Snack Foods
- Chemicals
- Agricultural Seed
- Cat Litter
- Bakery Mixes

**704-871-1159**

**HAMER  
FISCHBEIN®**

A DURAVANT COMPANY

Specifications are subject to change without notice.

