

FISCHBEIN®

Model 400 NS™

Plain Sew

Fischbein Model 400 NS™

The Fischbein Model 400 NS™ sets the industry standard for quality and cost-effective bag sewing. Operating at adjustable speeds up to 55 linear feet per minute, the Model 400 NS™ features an air thread pusher which directs the thread into the system's cutting knife. A safe automated infeed system automatically guides the top of the bag through the entire bag sewing process.



Model shown with
foldover infeed

EVERYTHING IN BAGGING EQUIPMENT™



Fischbein® Model 400 NS™

Plain Sew

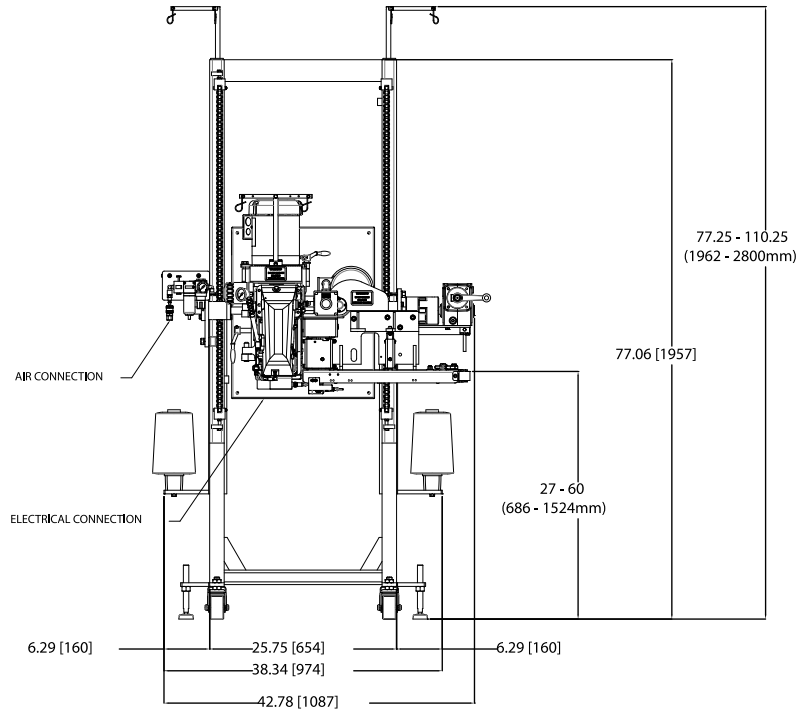
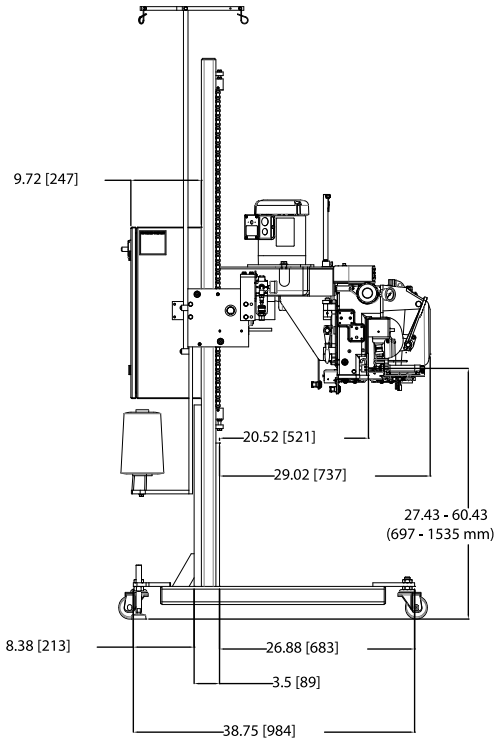

400NS

FEATURES

BAG TYPES

Closes a variety of pillow style or gusseted bags, including multi-wall paper, laminated and non-laminated woven polypropylene, and jute.

INFEED SYSTEM

Fast. Safe. Automated. The leading edge of the bag is fed into the infeed, which automatically guides the bag's top through the entire bag sewing process.

EMPRESS 100 SEWING HEAD

With its self-lubricating system, the Empress 100 delivers trouble-free, smooth performance with low vibration. Operating speed is adjustable from 35 to 55 linear feet per minute.

AIR THREAD-PUSHER

Without operator assistance, the air thread-pusher automatically directs the thread into the system's cutting knife.

SWING FEATURE

Fischbein's exclusive sewing-head swing feature makes threading the 400 NS™ a snap, and provides full access for cleaning and easy head removal.

OPTIONS

- Direct drive VFD package for synchronous sewing
- Motor starter and contactor for conveyor
- Optical thread break and oil sensor package
- 575 VAC
- Tagger Infeed
- Rotary knife thread cutter
- Corrosion resistant package with NEMA 4 rated electrics

SPECIFICATIONS

- Dimensions: L 46 in (117 cm), D 41 in (104 cm), H 78 in (198 cm)
- Speed: Up to 55 linear feet per minute
- Electric (NEMA 12): 230/380/460 VAC, 3 PH, 50/60 Hz
- Air: 1 cfm @ 90 PSI

BAGS

- Bag Types: Multi-wall paper, woven polypropylene, and jute bags, either pillow-style or gusseted.
- Bag Thickness: Maximum 12 mils
- Free Bag Top: Minimum 6 in (15.2 cm)

APPLICATIONS

- Fertilizers/Minerals
- Cat Litter
- Feed Additives
- Bakery Mixes
- Chemicals
- Pet Food
- Agricultural Seed
- Powdered Dairy Products

704-871-1159

**HAMER
FISCHBEIN®**

A DURAVANT COMPANY

Specifications are subject to change without notice.

